

Title **STEP_BaseBoard_1**
 Size: A4 Number: 1 Revision: V1.0
 Date: 2016/4/22 Time: 11:54:00 Sheet 1 of 2
 File: J:\PCB_Project\STEP_BaseBoard\STEP_BaseBoard_1.SchDoc



1

2

3

4

A

A

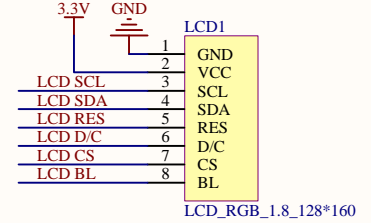
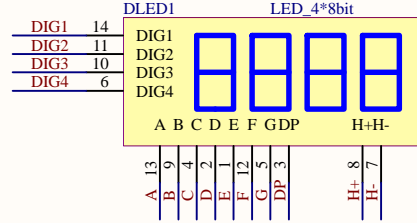
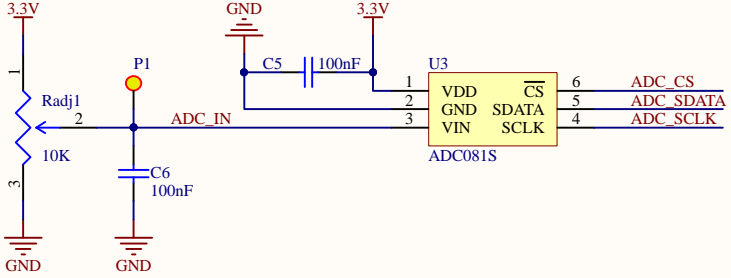

B

B

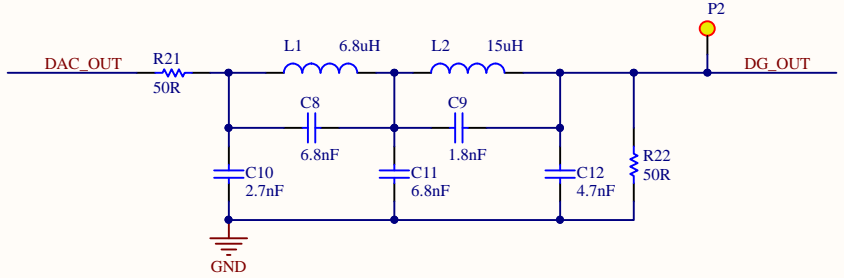
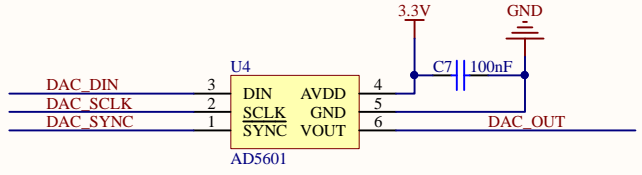

C

C

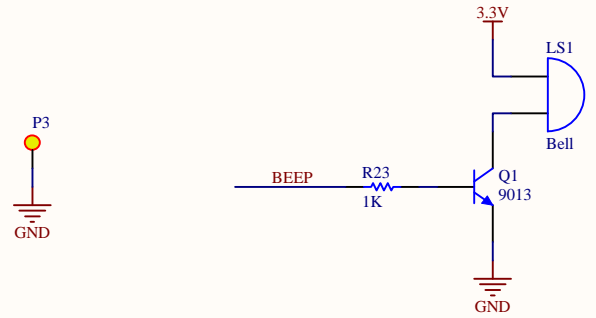
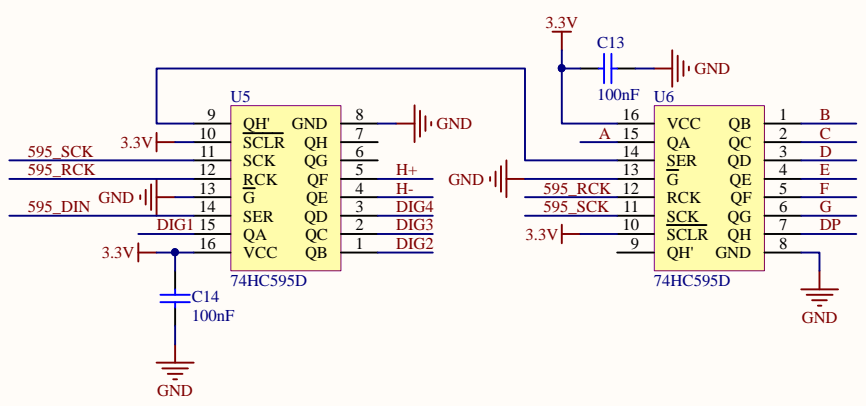

D

D

Title STEP_BaseBoard_2			* * * * *
Size: A4	Number: 2	Revision: V1.0	
Date: 2016/4/22	Time: 11:54:46	Sheet2 of 2	
File: J:\PCB_Project\STEP_BaseBoard\STEP_BaseBoard_2.SchDoc			
Altium			

1

2

3

4